



Università
della
Svizzera
italiana



UNIVERSITY OF
CAMBRIDGE

A Programmable Framework for Validating Data Planes

Pietro Giuseppe Bressana

Research Advisors:
Prof. Robert Soulé
Dr. Noa Zilberman

Emerging In-Network Computing

Smart NIC

Programmable switch

FPGA

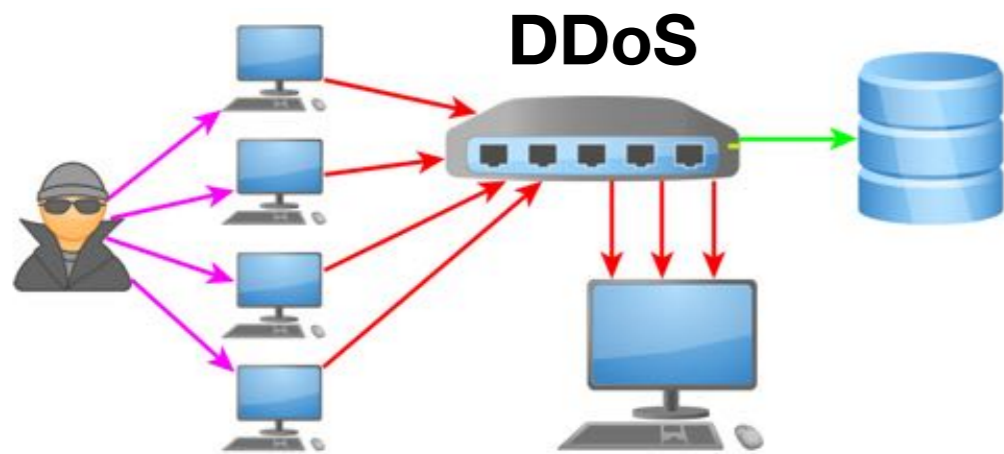

Consensus

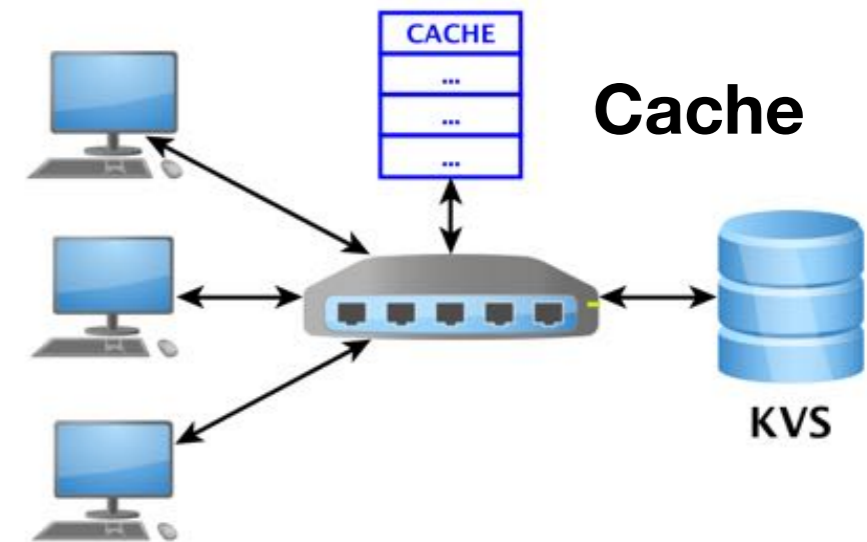
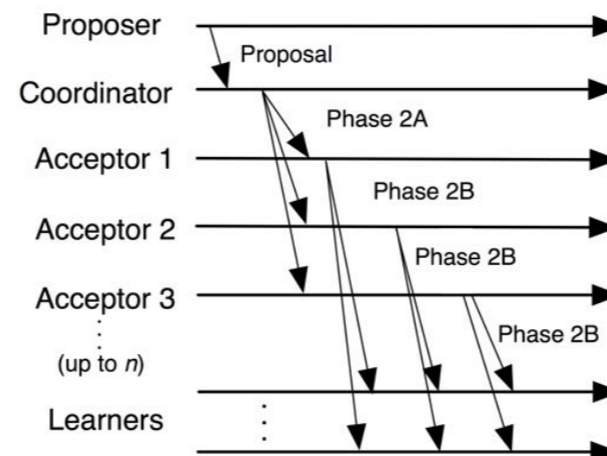

In-band Network Telemetry

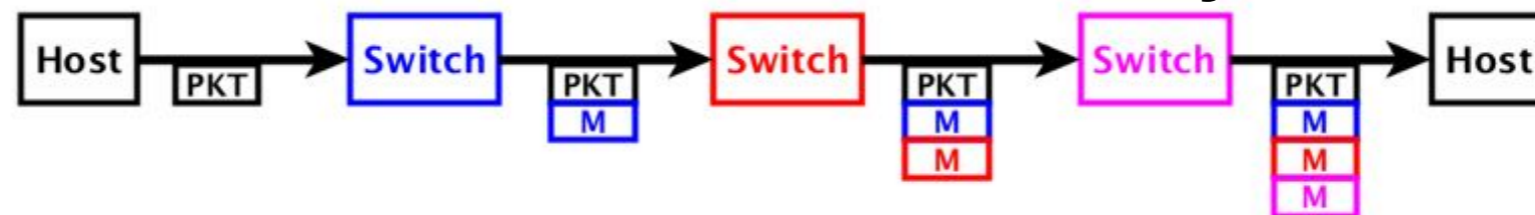

Programmable Hardware In The Cloud

nvidia GPU CLOUD

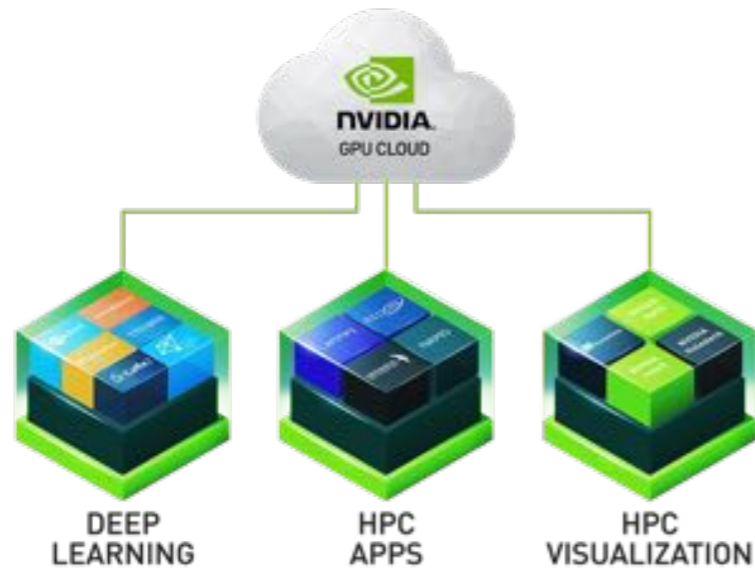

Microsoft Catapult

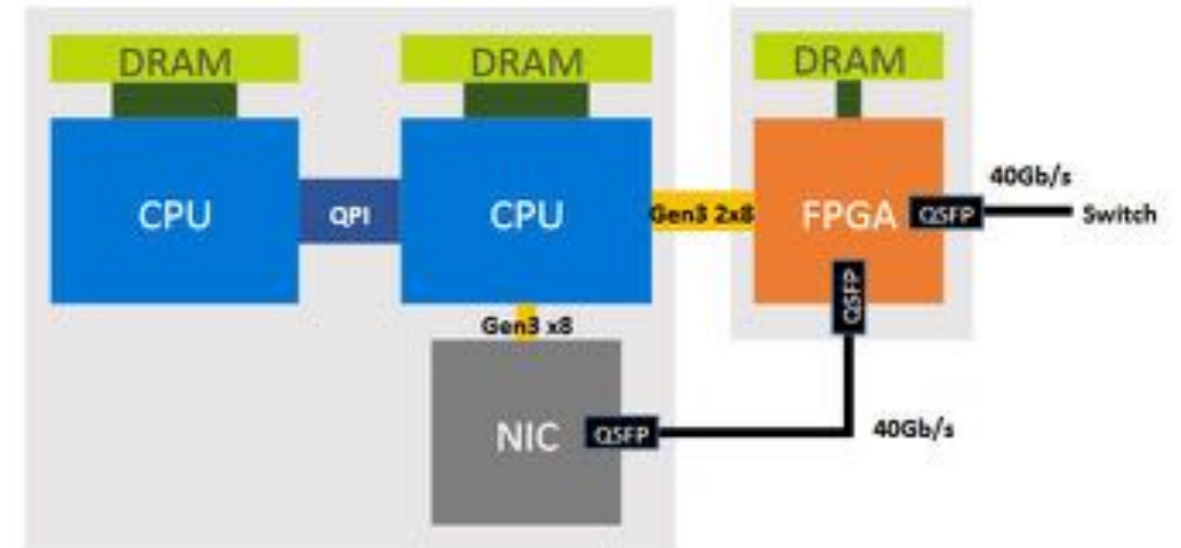

Google Cloud Platform (TPU)



Amazon EC2_F1

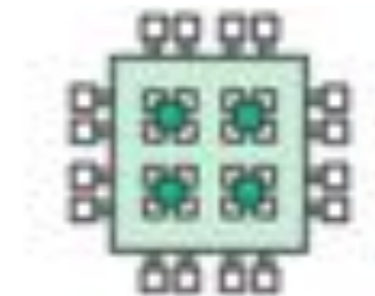

Some of these technologies are accessible to users

In-Network Computing: New Challenges

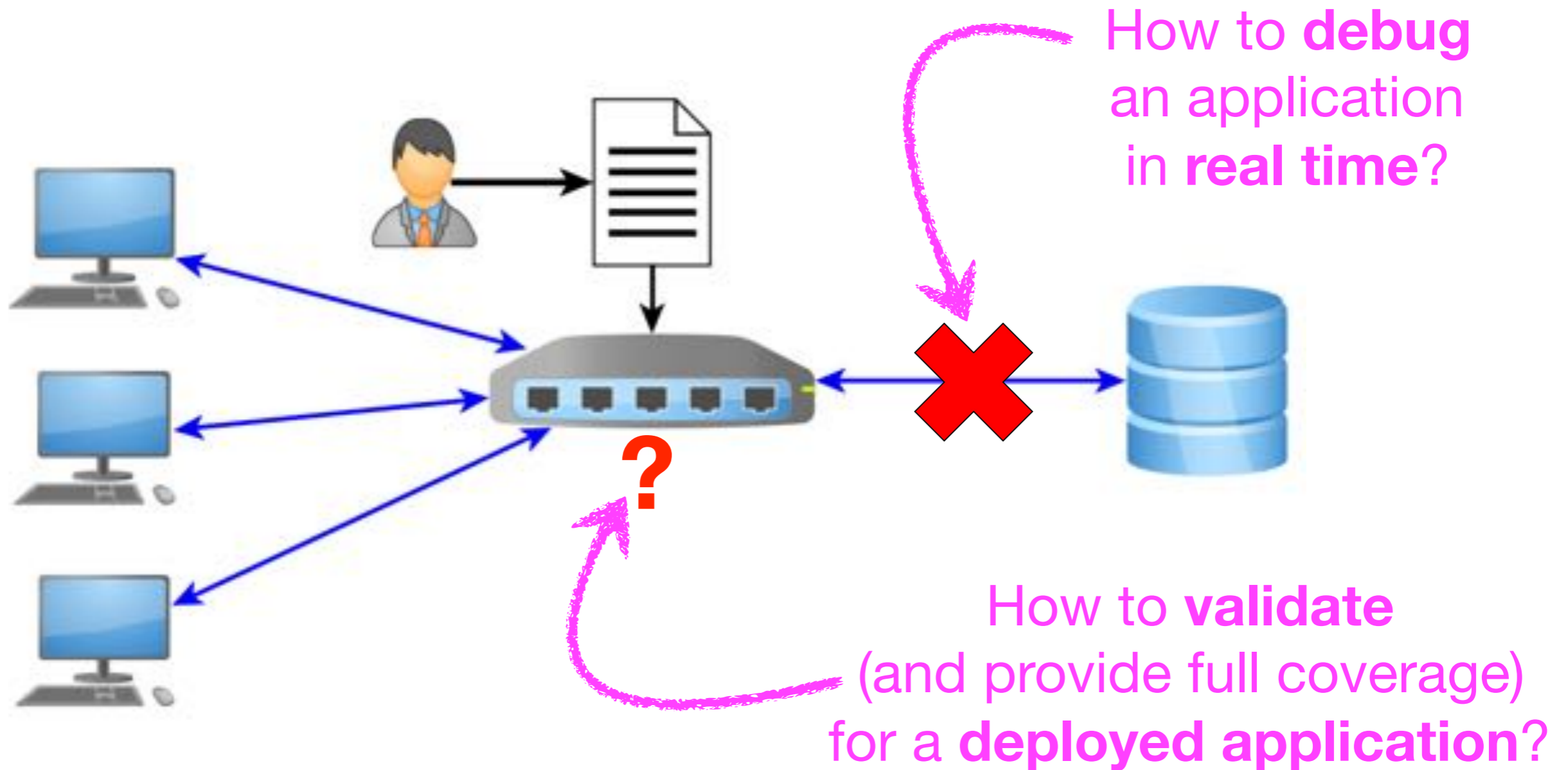

No software-like debugger in hardware

NetDebug

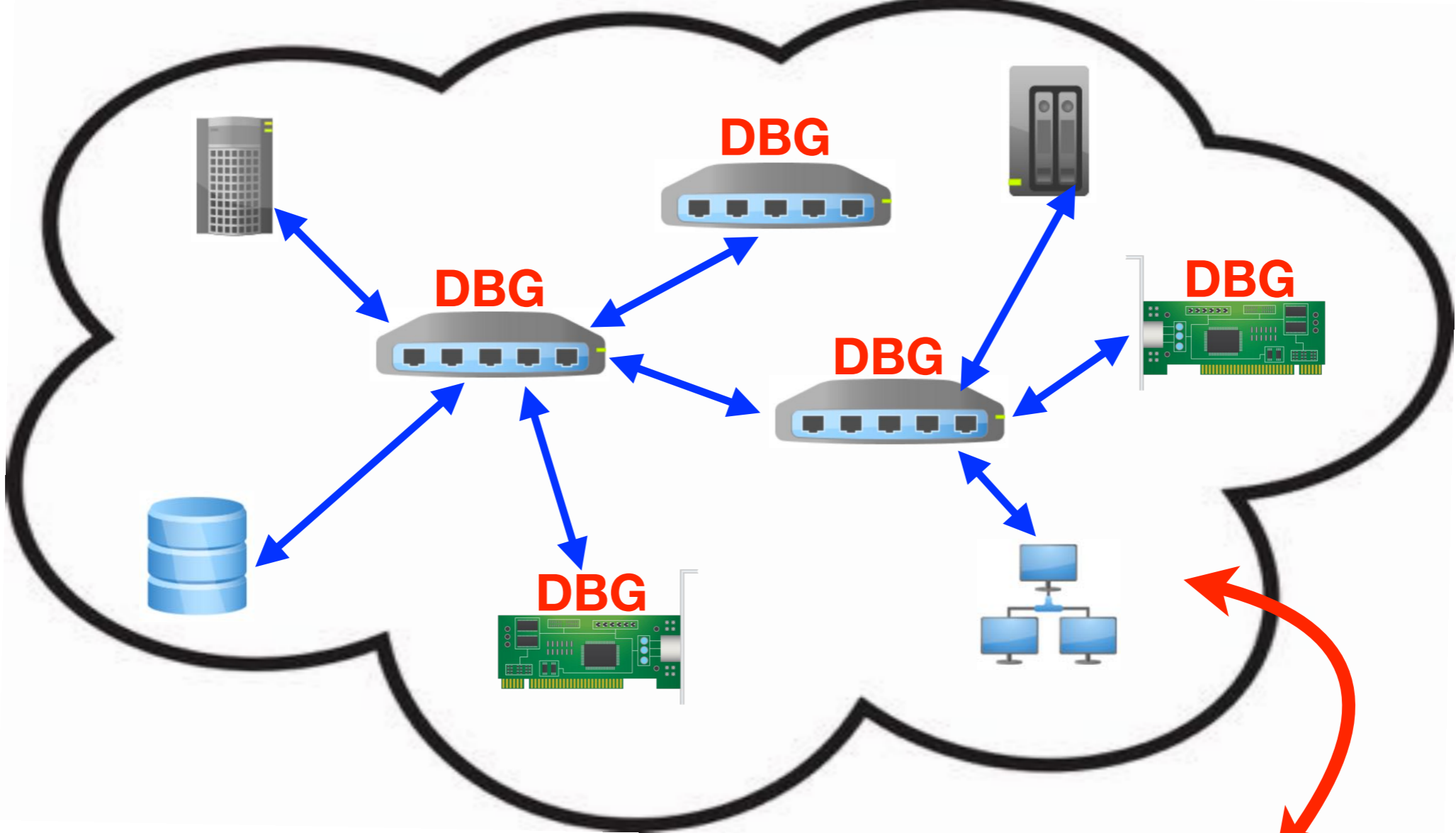

Validation & Real-time debugging of networked applications
(e.g. inside cloud environments)



NetDebug: Programmable Architecture

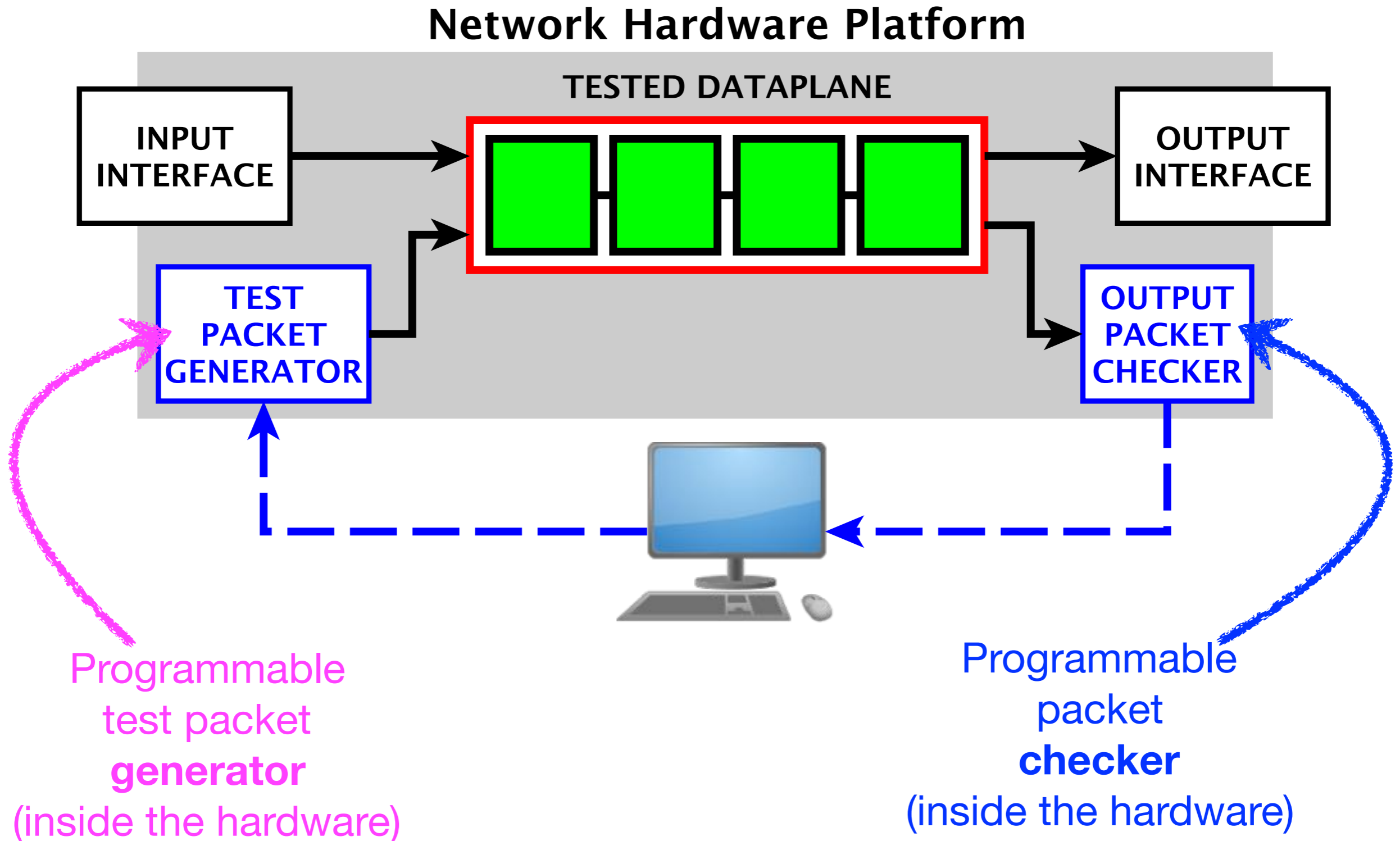

A Programmable Framework

P4:
a language for
designing
programmable data
planes



NetDebug:
create programmable
application-specific
validation environments

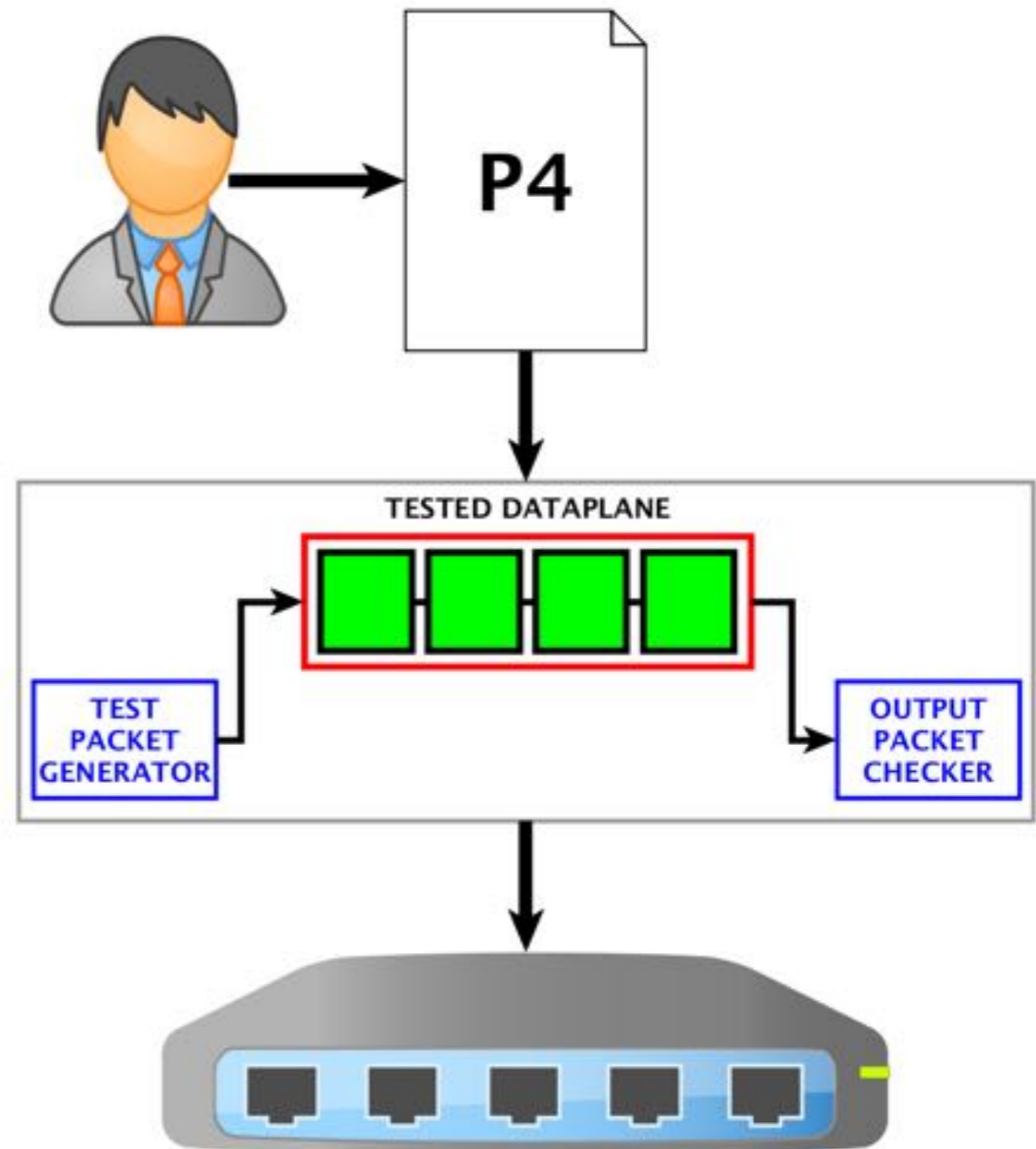

Software Formal Verification Tools

Program:
do something,
use specific
protocol

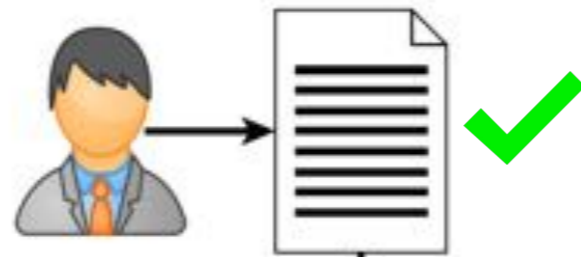

Parser code:
accepts specific headers,
rejects others



✓ Verification **passed**



PACKET

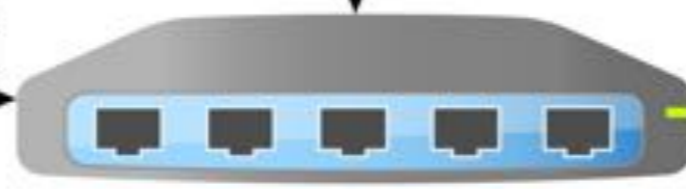

PACKET



All packets pass!!!
Nothing rejected
(dropped)

Reject function not implemented
by the compiler!
&
no warning provided!

Some bugs may be related to
the **compiler**
&
to the **architecture**

External Debuggers

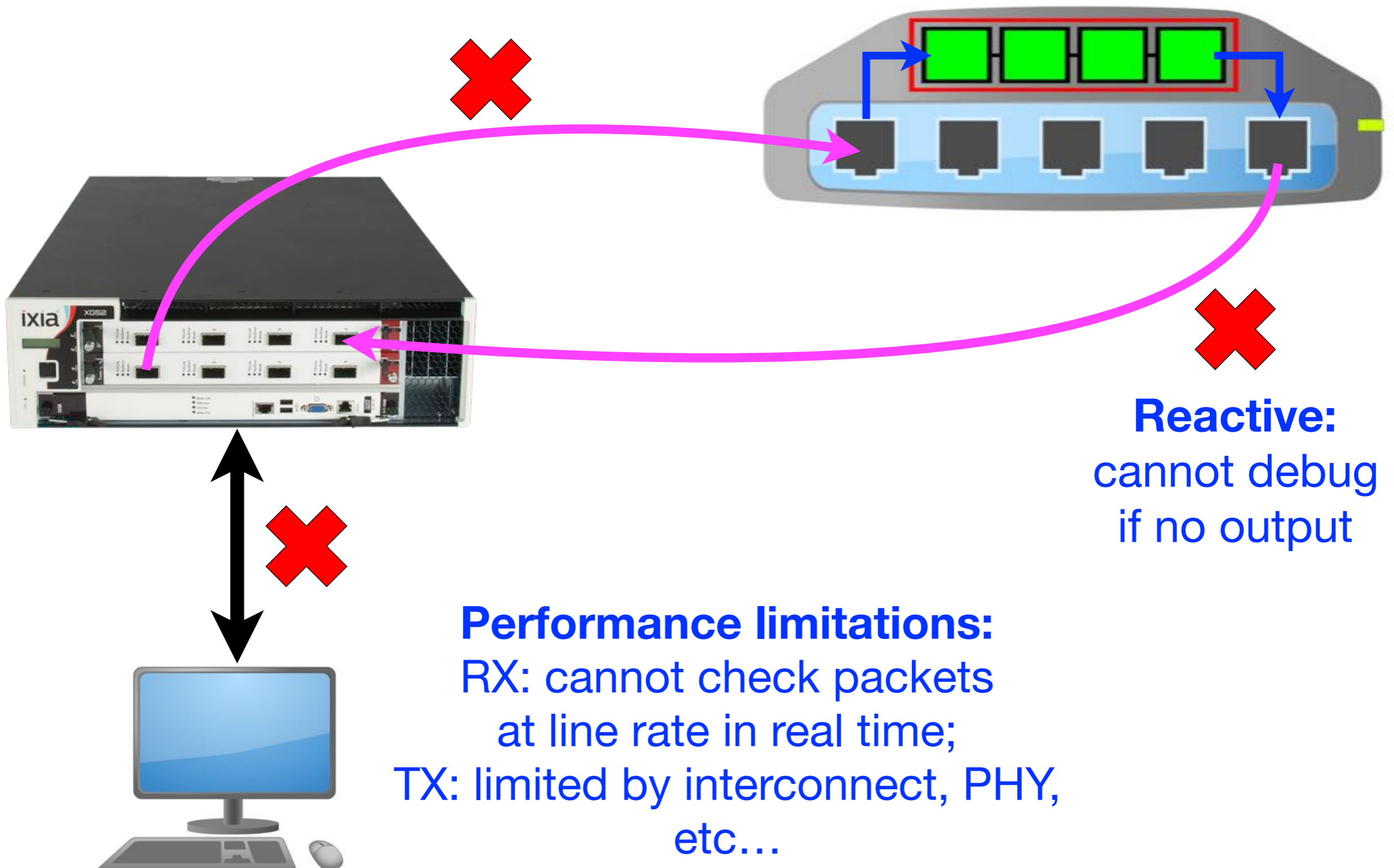

Debug Information

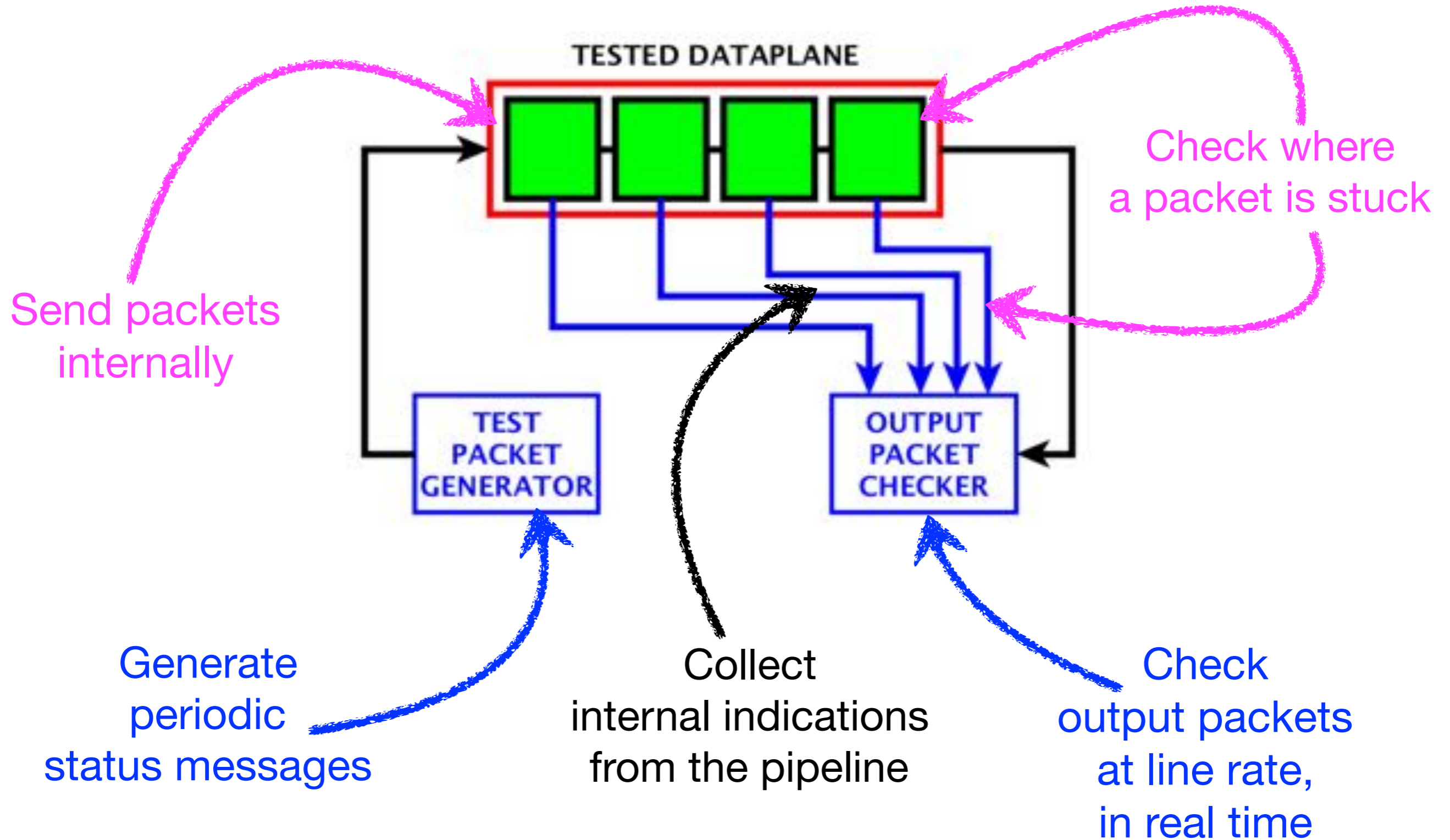

The Flexible Pipeline ...

Prototype test packet generator → Can test many programs **without recompiling** the design → Generate sequences of **customisable** packet headers

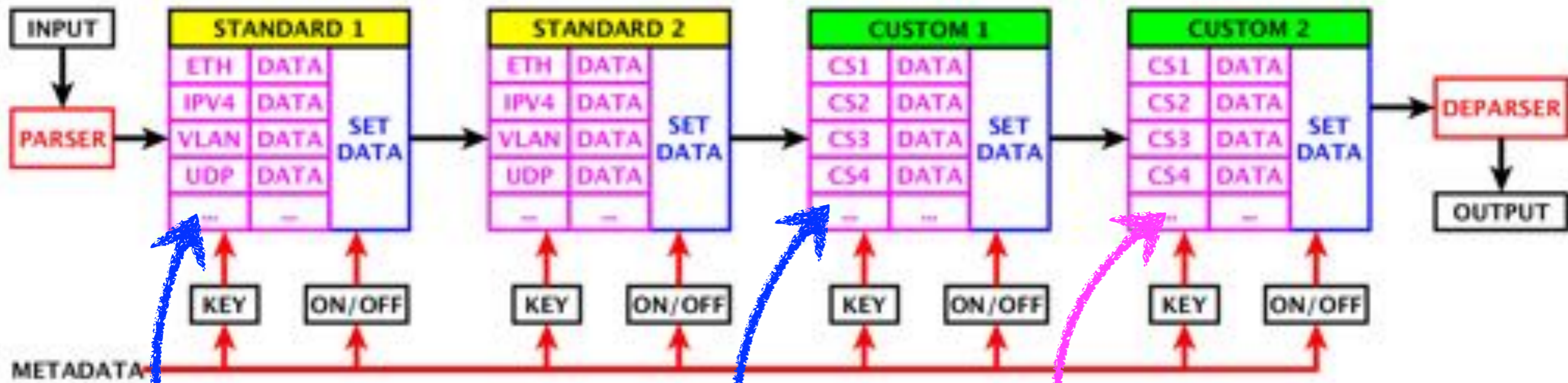

Standard & custom M/A stages

Header data provided by control plane (tables)

... Killed By Closed-Source Compilers

No open-source P4 to hardware compiler,
closed-source compilers are **limited**:

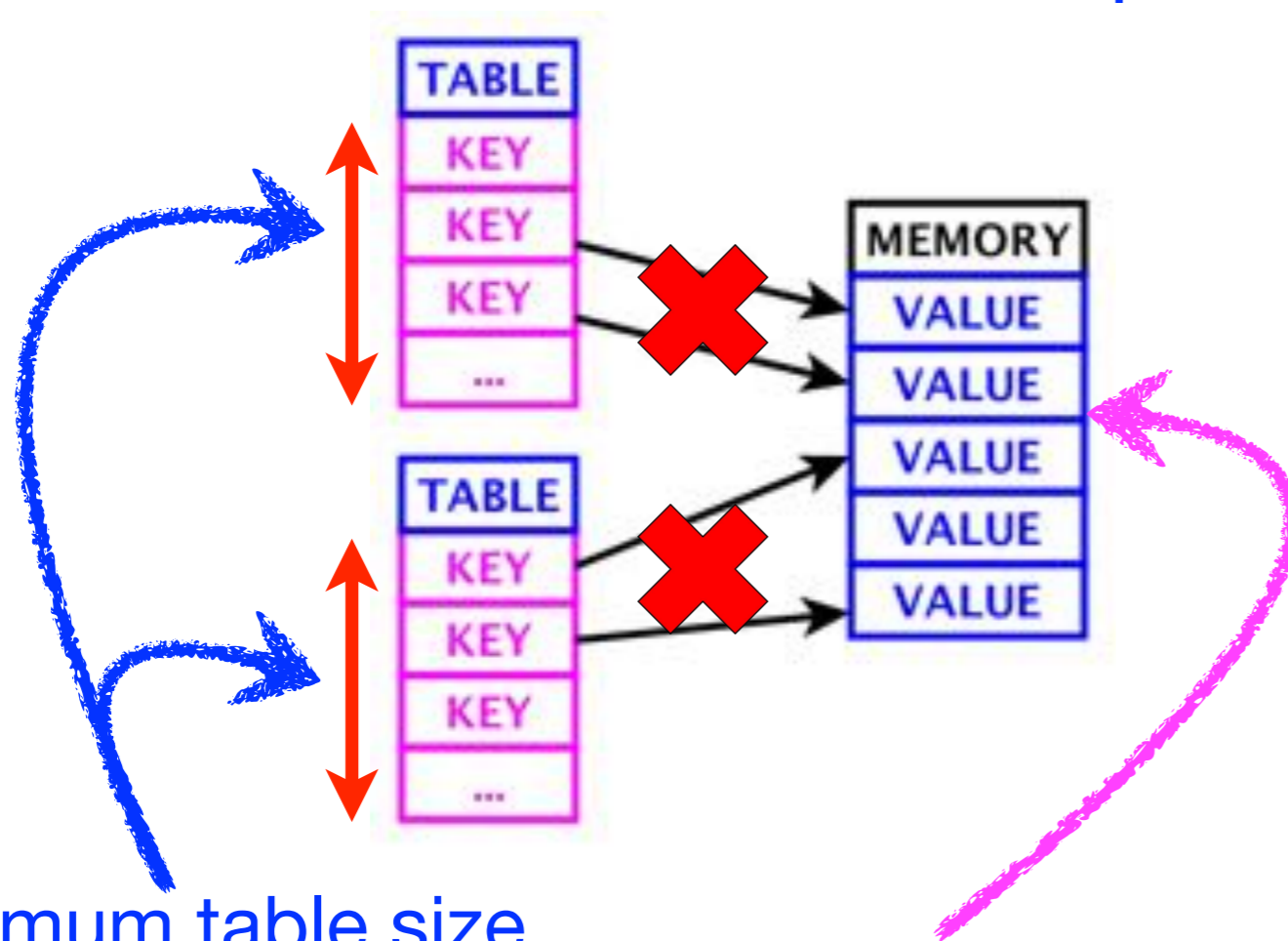

Minimum table size
(64 entries):
resource waste

Tables cannot
share memory

```
if (...) {  
    emit(p.eth);  
}  
else if (...) {  
    emit(p.ipv4);  
}  
else if (...) {  
    emit(p.udp);  
}  
...
```

Conditions lead to
resource explosion

Need to balance flexibility & resource usage

Evaluation of NetDebug

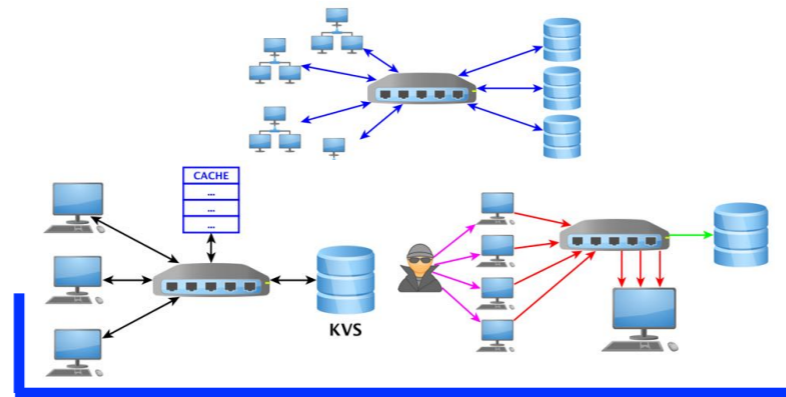

Flexibility:
number of use-cases tested
with the same NetDebug
configuration



Functionality:
coverage of possible
combinations,
number of bugs found, ...

DEBUG
PACKET
GENERATOR

VERIFIER

Resources:
overhead of adding
NetDebug

Performance:
overhead of adding NetDebug,
max rate that can be debugged,
runtime, ...

Ongoing & Future Work

- ✓ Programmable generator;
- ✓ Programmable checker;
- ✓ Management interface;
- ✓ Tested learning switch;

➔ More use-cases:

Network caching

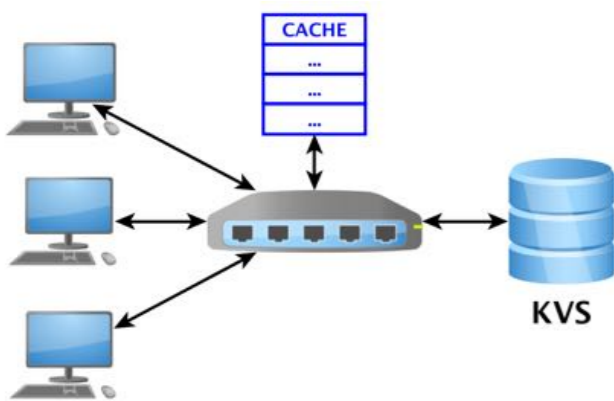

Consensus

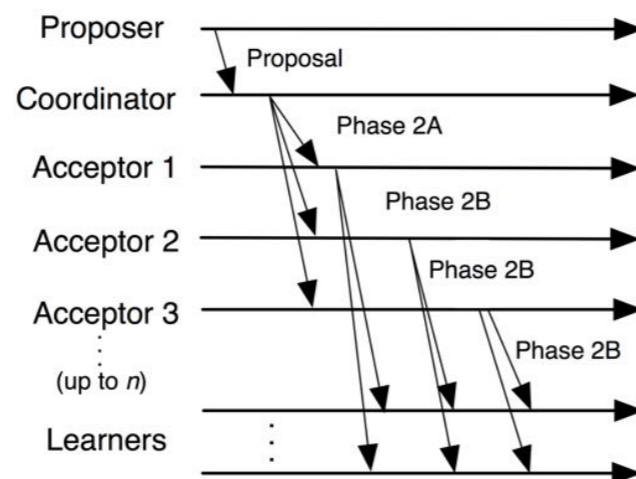

Language extensions:

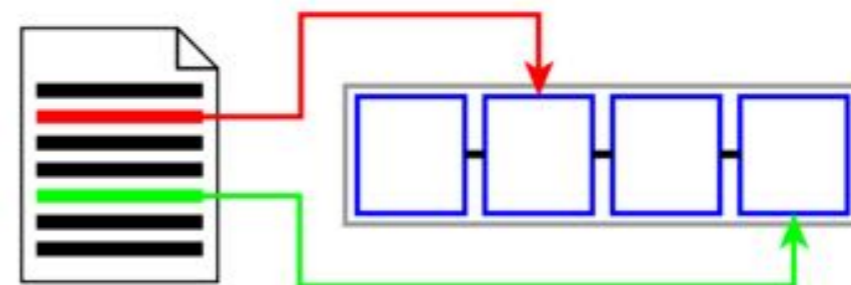
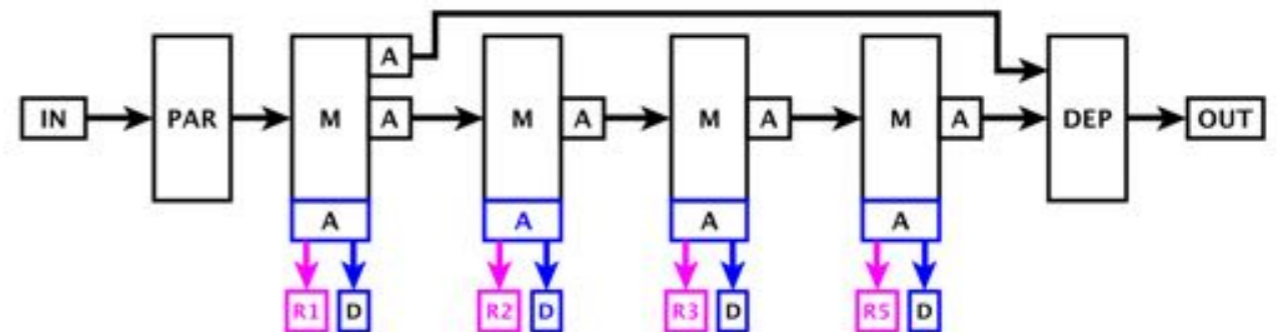
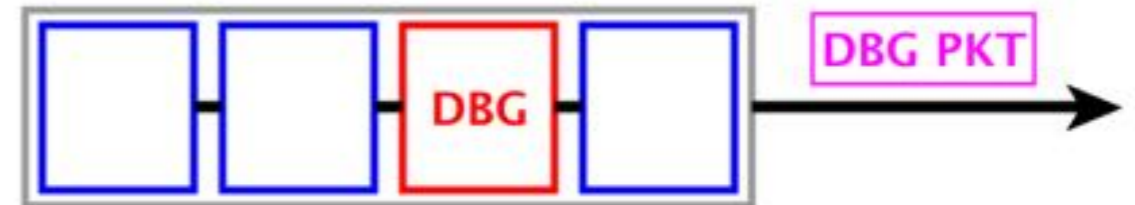

Conclusions

Emerging **in-network computing**

Need a **validation & real-time debugging** infrastructure



Programmable data-planes: great **flexibility**



NetDebug: debugging network applications



enables
validation



detects bugs hidden
from verification tools



programmable &
open-source

Summary & Questions

